

ELLA-DS95-G-25W

Specification

Type	Downlight
Cutout	Ø95mm.
Glare Cut Off Angle	40°
Weight	0.45 kg
Frame	Die-cast aluminum (matt white)
Cone	Aluminum (mirror finish)
Driver	Remote
IP Rating	IP20
Power	25W

Beam Angle	15°, 24°, 36°, 60°
Color Temperature	2700K, 3000K, 4000K
Color Rendering	≥ 90
Rated Lumen Output	2000lm

Light Body Color



Reflective Cup Color



Driver Specifications

Model Number	Driver LC 25W 450-600mA flexc SR SNC4
Dimming	Non-Dimmable
Operating Voltage	AC200-240V
Power Consumption(with Driver)	25W
Dimension	L:147 W:43 H:30
Weight	0.076 kg.



Cone color

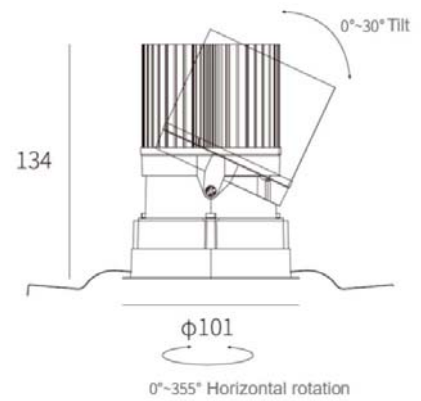

Photometric Data

